

# AirTempo<sup>®</sup>

Wireless Touch Control with Steamhead



Installation, Operation & Maintenance Manual

mr.steam<sup>®</sup>

When installing and using this electrical equipment, basic safety precautions should always be followed, including the following:

## IMPORTANT SAFETY INSTRUCTIONS

### 1. READ AND FOLLOW ALL INSTRUCTIONS

2. **⚠️ WARNING** Do not permit children under the age of 16 to use this steambath.
3. **⚠️ WARNING** Steam is hot and can cause injury or death if improperly used. Steam rooms contain steam and elevated temperatures. Please read and observe all warnings in this manual before installing or using a steam room.
4. **⚠️ WARNING** To reduce the risk of injury:
  - A. The wet surfaces of steam enclosures may be slippery. Use care when entering or leaving.
  - B. The steam head is hot. Do not touch the steamhead and avoid the steam near the steamhead.
  - C. Prolonged use of the steam system can raise excessively the internal human body temperature and impair the body's ability to regulate its internal temperature (hyper-

thermia). Limit your use of steam to 10-15 minutes until you are certain of your body's reaction.

- D. Excessive temperatures have a high potential for causing fetal damage during the early months of pregnancy. Pregnant or possibly pregnant women should consult a physician regarding correct exposure.
- E. Obese persons and persons with a history of heart disease, low or high blood pressure, circulatory system problems, or diabetes should consult a physician before using a steambath.
- F. Persons using medication should consult a physician before using a steambath since some medication may induce drowsiness while other medications may affect heart rate, blood pressure and circulation.

**HYPERTHERMIA** occurs when the internal temperature of the body reaches a level several degrees above the normal body temperature of 98.6° F. The symptoms of hyperthermia include an increase in the internal temperature of the body, dizziness, lethargy, drowsiness, and fainting. The effects of hyperthermia include:

- a) Failure to perceive heat;
- b) Failure to recognize the need to exit the steambath;
- c) Unawareness of impending risk;
- d) Fetal damage in pregnant women;
- e) Physical inability to exit the steambath; and
- f) Unconsciousness.

**⚠️ WARNING** The use of alcohol, drugs, or medication can greatly increase the risk of hyperthermia.

## SAVE THESE INSTRUCTIONS

## READ ME FIRST!

**!WARNING** As you follow these instructions, you will notice warning and caution symbols. This blocked information is important for the safe and efficient installation and operation of the steambath system. These are types of potential hazards that may occur during installation and operation:

**!WARNING** Indicates a potentially hazardous situation, which could result in death or serious injury.

**!CAUTION** Indicates a potentially hazardous situation, which may result in minor or moderate injury or product damage.

**IMPORTANT NOTE:** This highlights information that is especially relevant to a problem-free installation.

All information in these instructions is based on the latest product information available at the time of publication. Sussman-Automatic Corporation reserves the right to make changes at any time without notice.

## Table of Contents:

Important Safety Instructions.....	2
Before Installing.....	4
Dimensional Information .....	5
Installation .....	6
Surface Mount & Glass Mount.....	6-7
Wireless Receiver.....	7-8
Remote Temperature Probe.....	9-11
AirTempo Operating Instructions.....	12-14
Battery Replacement .....	15
System Status Codes.....	16
Pairing, Care & Maintenance, Warranty .....	16
Conformity & Compliances .....	17
FCC Statements .....	18
Parts List & Technical Specs .....	19
Glass Mount Mask .....	20-21
Flush Mount Installation .....	22-23
Flush Mount Template .....	23

## Before Installing

Carefully inspect the control and packaging for shipping damage. In the event of shipping damage, please contact the carrier for claim information. Our customer service department can assist you with any missing or damaged parts.

**⚠CAUTION** To avoid unintentional steambath operation, do not locate the control where other controls, accessories, shower heads, valves, body sprays or similar within the shower could cause confusion or interfere with the MrSteam control's intended use and function.

Do not use any AirTempo®, iSteam®, iTempoPlus®, iTempo®, HomeWizard® or iGenie® controls without reading and understanding the respective Installation and Operation Manual and MrSteam steam generator Installation and Operation Manual. Failure to read and understand these instructions may result in an inoperative or hazardous installation.

**⚠WARNING** A peel and stick warning sticker is provided in the MrSteam steam generator Installation, Operation and Maintenance Manual. This manual is provided with every steam generator. The warning sticker must be read and permanently affixed in a conspicuous location near the steam room. Failure to read and affix this warning sticker in a conspicuous location may result in serious injury or death. Please call MrSteam at 800 767-8326 for a free replacement or if you have any questions regarding the warning sticker.

Install the AirTempo, iSteam, iTempo or iTempoPlus controls according to installation instructions. Failure to install according to instructions will result in an inoperative control or hazardous overheating or inadequate heating of the steam room. If an AirTempo, iSteam, iTempo or iTempoPlus control is installed outside the steam

room a Remote Temperature Probe (PN MST5) must be installed inside the steam room per instructions for the Remote Temperature Probe. Failure to install according to instructions will result in an inoperative control and overheating of the steam room.

**⚠WARNING** Do not route AirTempo, iSteam, iTempoPlus, iTempo, Home Wizard or iGenie control wiring inside conduit together with power lines or close to hot water or steam piping. Doing so may result in an inoperative or hazardous installation.

**⚠WARNING** Do not alter or modify any MrSteam product. Doing so may result in an inoperative or hazardous installation and will void the warranty.

### IMPORTANT NOTES:

- Turn power to the steam generator OFF before connecting the control to the generator. Failure to turn the power off will result in an inoperable control.
- Do not operate AirTempo, iTempoPlus, iTempo, Home Wizard or iGenie controls with anything other than a MrSteam eTempo compatible steam generator. MrSteam residential steam generators with serial numbers lower than 900000, or any other brand of steam generator are not to be operated with AirTempo, iTempoPlus, iTempo, Home Wizard or iGenie controls. Doing so may result in an inoperative installation.
- This document contains important safety, operation and maintenance information. Leave this document with the homeowner. Do not discard this document.
- Discontinue use of the steam generator or control if the steam generator is damaged or otherwise not functioning properly. Doing so may result in an inoperative or hazardous installation.
- All drawings are for illustrative purposes only.

## Dimensional Information for the AirTempo

### BOX CONTENTS:

- AirTempo Control
- Decorative Trim
- Cable (3 ft.)
- Wireless Receiver
- Batteries (2)
- Mounting Screws (2)
- Steamhead
- Tube of Silicone Sealant
- Surface Mount Bayonet
- Owner's Manual

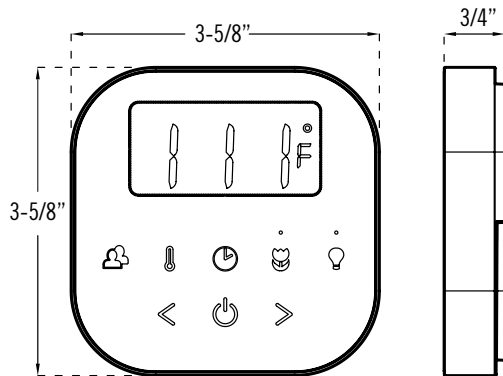

AirTempo  
(shown with decorative trim)

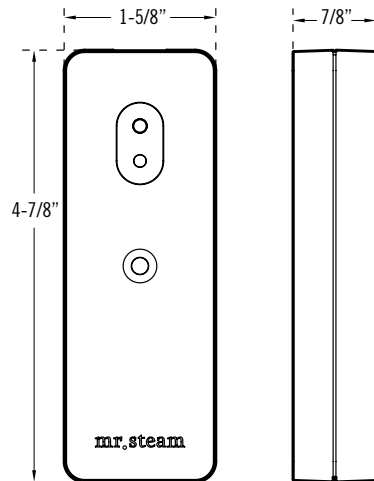

Wireless Receiver

*Drawings for illustrative purposes only*

## Installation Instructions for AirTempo

### STEP 1

Determine the desired installation location of the control. The AirTempo controls are designed to be installed inside or outside the steam room as a matter of personal preference. If the control is installed outside the steam room a Remote Temperature Probe part number MSTS must be installed inside the steam room.

**IMPORTANT NOTE:** See installation instructions for the MSTS Temperature Probe (pgs.10-12) before rough-in or installation of control.

If the control is installed inside the steam room the control must be located:

- 4-5 feet above the floor near the bather seating area.
- On a vertical wall

The control features an integral temperature sensor. Locate the control in a location representative of the desired steam bathing temperatures. Do not locate the control above or near the steam head or direct steam emissions. Locating the controls near the steamhead or near direct steam emissions may result in poor steam room temperature control.

The control can be located up to 60 feet from the wireless receiver.

Construction materials affect the communication between the control and receiver. Test the range of the AirTempo. It may be necessary to change the location of the wireless receiver to improve the range.

Contact MrSteam technical service for an optional 30 or 60 foot cable.

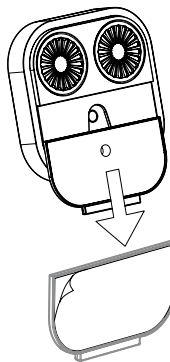

### STEP 2

The AirTempo control can be surface or flush mounted according to personal preference. Flush mount components are sold separately (104232RD & 104232SQ). Contact a MrSteam representative if a flush mount kit is needed, see page 22.

#### Surface Mount AirTempo

- Remove the surface mount bayonet from the back of the AirTempo Control.
- Remove & discard the release paper to expose the adhesive liner.
- Ensure the mounting surface is clean & dry.
- Place the bayonet on the wall in the desired location.
- Wait 15 minutes before placing the control on the bayonet to ensure the adhesive is secured

**IMPORTANT NOTE:** Use the screw and anchor provided to secure the bayonet to the wall as required for rough or uneven wall surfaces. The surface mount bayonet supports the weight of the AirTempo control.

## Mounting on Glass

When installing AirTempo on glass a peel and stick film is provided on pages 20-21 and may be used as a mask for a clean look from behind the glass.

## Wireless Receiver Installation

The control can be located up to 60 feet from the wireless receiver. Construction materials may affect the communication between the control and the receiver. Test the range of the AirTempo. It may be necessary to change the location of the wireless receiver to improve the range. Contact MrSteam technical service for an optional 30 or 60 foot cable.

Using the 3 foot cable provided, plug one end into the steam bath generator and the other end into the AirTempo.

Attach the dongle on a wall adjacent to the steam generator using the screw provided.

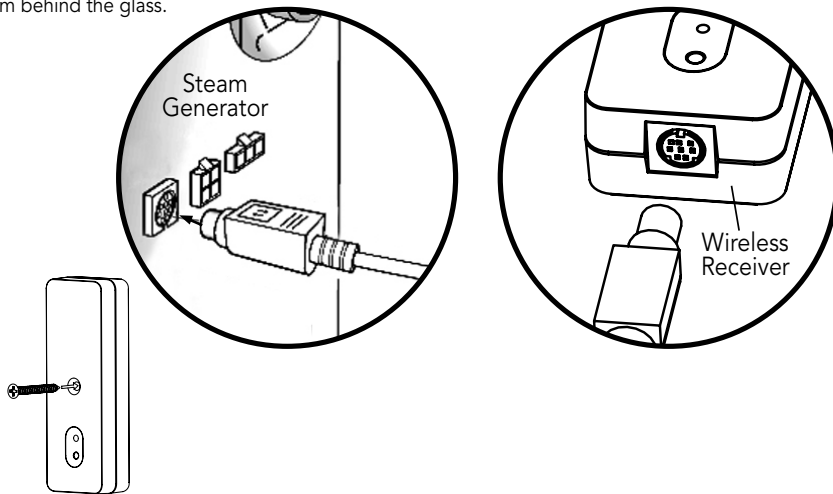

**IMPORTANT NOTE:** Do not rest the dongle on the steam generator, the metal case of the generator may shield the RF signal.

The control features an integral temperature sensor. Locate the control in a location representative of the desired steam bathing temperatures. Do not locate the control above or near the steam head or direct steam emissions.

**CAUTION** To avoid unintentional steambath operation, do not locate the control where other controls, accessories, shower heads, valves, body sprays or similar within the shower could cause confusion or interfere with the MrSteam control's intended use and function.

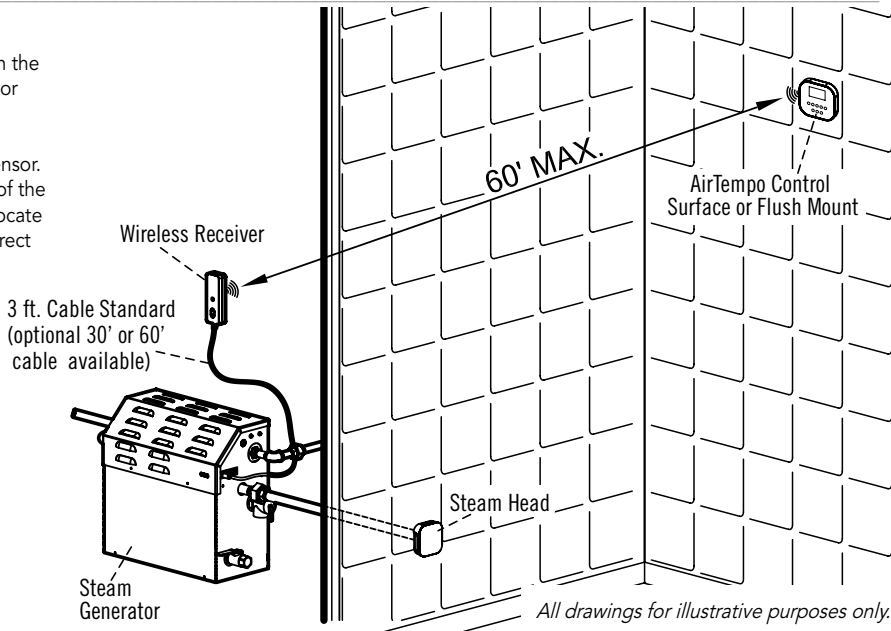



## Installing the Remote Temperature Probe (PN: MST5)

**⚠ CAUTION** The Remote Temperature Probe is required when the AirTempo control is installed outside the steam room. Failure to install the probe, or failure to install the probe correctly will result in an inoperable control and result in excessive temperatures and a hazardous condition.

**⚠ CAUTION** The Remote Temperature Probe is for use with AirTempo, iTempo and iTempoPlus controls only. Do not use with any other controls. Do not use any other temperature probe with the AirTempo, iTempo and iTempoPlus controls. Noncompatible products may result in an inoperative control and a hazardous condition.

**⚠ CAUTION** Install the AirTempo controls according to the installation instructions on pages 6-7. Failure to do so may result in an inoperative control and a hazardous condition.

1. Determine the location of the Remote Temperature Probe:  
The Remote Temperature Probe must be installed:
  - a. On a vertical surface
  - b. 4-5 feet above the floor
  - c. in a location representative of the desired steam bathing temperature.

Locating the MST5 near the steamhead or near direct steam emissions may result in poor steam room temperature control.

- d. The probe has an integral 30' cable. Insure that the probe and/or steam generator are located accordingly.
2. Drill a 5/16 inch diameter hole in the wall.  
Do not oversize or under size the hole. Clean area thoroughly.
- NOTE:** The silicone supplied by MrSteam can be used to meet a variety of sealing and gasketing. It cures to silicone rubber and adheres to glass, wood, metal, porcelain, ceramic tile, painted surfaces, many plastics and rubber. Surfaces must be clean and dry. Apply thin layer of product. Fit together and support if necessary. Allow excess material to cure, then trim with a sharp blade. Sealant "skins" in 5 minutes, dries to touch in 1 hour. Fully cures and bonds in 24 hrs.
3. Remove the knock-out from the steam generator jacket as shown in Diagram 1.
  4. Insert the probe cable through the knock-out and connect to the connector on the steam generator printed circuit board marked EXT TEMP as shown in Diagram 1.

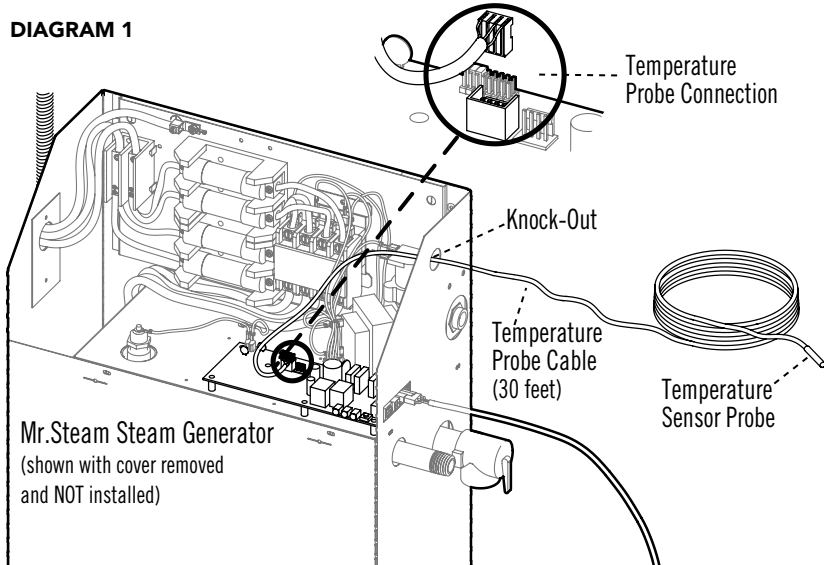

*Drawings for Illustrative Purposes Only.*

5. Route the end of the probe cable with the temperature probe through the wall into the steam room as shown in Diagram 2.

**IMPORTANT NOTE:** Do not strain, staple, pinch or otherwise damage the probe cable.

6. With a minimal length of the cable exposed apply silicone (provided) to the hole in the wall as required to create a moisture seal as shown in Diagram 2.

7. Push the temperature cable and probe into hole as required to leave minimum 1/4", maximum 1/2" of the bulb exposed as shown.

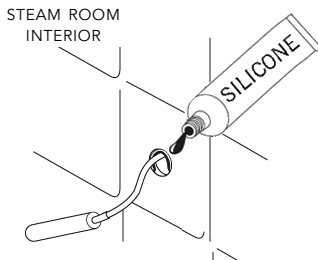
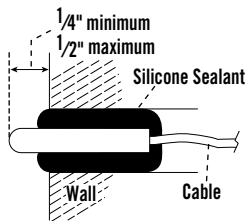
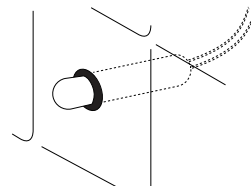

Diagram 2



Sectional View



**Installed Remote Temperature Probe**  
showing a minimum of 1/4" of the probe exposed to steam room air

**!WARNING** Insure a minimum of 1/4" of the temperature probe is exposed to the air. Failure to do so may interfere with the ability to sense temperature and may result in excessive steam room temperatures.

**!WARNING** The exposed area of the temperature probe must be free of silicone or any materials or obstructions that prevent direct exposure to the steam room air. Failure to do so may interfere with the ability to sense temperature and may result in excessive steam room temperatures.

**NOTE:** For Illustrative Purposes Only. Drawings Not to Scale

## AirTempo Operating Instructions

The AirTempo features programmable temperature control, programmable time duration, AromaSteam ON/OFF, ChromaSteam® control and two personal settings.

The LCD will be OFF until a button is pressed. The LCD remains lit for 10 seconds after the last button is pressed. When the steam generator turns OFF the display will turn on and read OFF. While the generator is steaming the LED above AROMA and CHROMA will alternately flash every 2 seconds.

**!WARNING** Set the steam bathing temperature according to personal preference, however it is highly recommended to begin steam bathing at a low temperature setting for a very short duration to gauge comfort and safety levels.

### ON/OFF Diagram 1

Press the ON/OFF key for 1 second to start the flow of steam. The Temperature Set Point is displayed. Steam will begin to flow a few minutes after the control is turned ON. The duration required for the steam room to reach steam bathing temperatures depends on the steam room construction and steam generator specifications. To stop the flow of steam before time expires press the ON/OFF key. Steam may continue to flow for a short time after the control is turned OFF

### SETTING THE STEAMBATH DURATION

#### Diagram 2

Press TIME key to set or display the steambath duration time. The control is pre-set and will display a TIME setting of 20 minutes (default setting). With the TIME displayed, press the LEFT or RIGHT arrows to set the desired duration time (2-60 minutes) in two minute increments.

Diagram 1

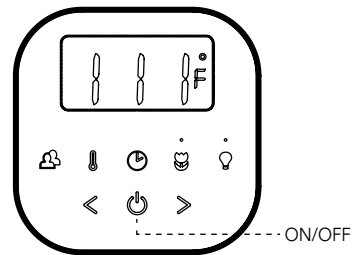
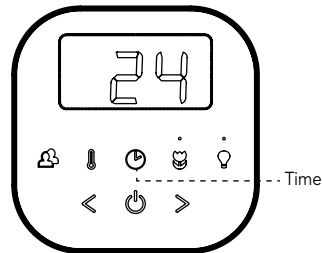

Diagram 2



### SETTING THE TEMPERATURE

Diagram 3: Press TEMP key to set the desired temperature or display the temperature setting. The control is preset and will display a temperature setting of 110°F (default setting). With the temperature displayed, press the LEFT or RIGHT arrows to set the desired temperature (80°F to 120°F) in one degree increments. Set the steam bathing temperature according to personal preference, however it is highly recommended to begin steam bathing at a low temperature setting to gauge comfort and safety levels.

### MEMORY FEATURE

If the control is turned off manually before it times out then the default settings of 20 minutes and 110°F will be used the next time the control is turned on. If the control times out (not manually turned off) then the previous user time and temperature settings will be used when the steambath is turned on.

### USER PRESETS Diagram 4

Use the  key program to store preferred settings.

To program preferred settings:

Press ON/OFF key to turn generator on. Press  key once to program PROG1.

Press it twice to program PROG2. The selected setting will be displayed.

Enter the preferred time and temperature settings.

The AirTempo will store the following settings: Set point, Time duration & Aroma state.

To select PROG1 or PROG2:

Press ON/OFF key then press  key once to select PROG1, press it twice to select PROG2.

The steambath will operate at the stored settings.

Diagram 3

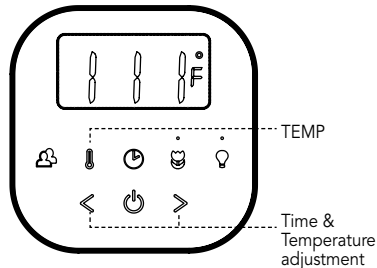
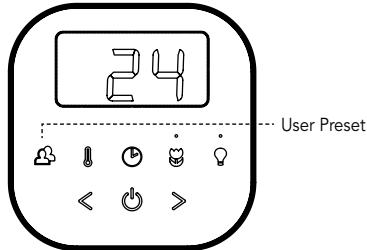

Diagram 4





AROMA

### AROMASTEAM

The AromaSteam is an optional accessory that automatically injects aromatic oil into the steam. Press the ON/OFF key to turn the steam generator on. Then, press the AROMA key. The Aroma indicator will turn ON. The AromaSteam turns off automatically when the steam generator stops heating. Press the AROMA key to turn it off during a steam session. The indicator will turn off. To conserve battery life, the indicator will only be lit when the display is ON.



CHROMA

### CHROMASTEAM

The ChromaSteam is an optional accessory that provides colored light in the steam room. Press the CHROMA key to turn light on. Press twice to select the next color. Press again to turn the light off. Note that the light can be turned ON even if the steam generator is OFF. To conserve battery, the indicator will only be lit when the display is ON.



TEMP

### CHANGING THE TEMPERATURE UNITS (°F/°C)

When the generator is ON, press and hold the TEMP key for 10 seconds. The temperature units will toggle to Fahrenheit (F) or Celsius (C).

### USING AIRTEMPO AS A REMOTE

The AirTempo can be removed from its holder and used as a remote control to warm up the steam shower. When AirTempo is returned to its holder the steam generator will run for the full set duration. After 10 minutes the steam generator turns off if the AirTempo is not returned to its dock. The steam generator will not restart unless AirTempo is in its dock.

### USING iGENIE WITH AIRTEMPO

iGenie will allow the steam generator to warm up the steam room for 10 minutes. To continue the steam bath session press any button on the AirTempo control. After 10 minutes the steam generator turns off if the AirTempo is not touched. The steam generator will not restart unless AirTempo is in its dock.

## Battery Replacement

The batteries in AirTempo will need periodic replacement. Both batteries should be replaced at the same time with new CR2450 coin cell batteries.

**⚠️ WARNING** CHOKE HAZARD. The batteries and battery doors are small pieces, keep out of reach of children.

**⚠️ WARNING** KEEP BATTERIES OUT OF REACH OF CHILDREN. Swallowing may lead to serious injury or death in as little as 2 hours due to chemical burns and potential perforation of the esophagus. Immediately see a doctor.

Remove the AirTempo from the wall by sliding it up and off the bayonet holder. The AirTempo comes off the flush mount holder by grasping the bezel and pulling the assembly straight out of the flush mount box.

Use a soft cloth to dry off the control.

With two fingers turn the battery doors in the direction noted. The left battery cover is opened by turning it clockwise, the right cover is opened by turning it counterclockwise.

Discard both batteries and replace with new batteries, the positive side of the battery goes towards the "+" symbol on the battery door.

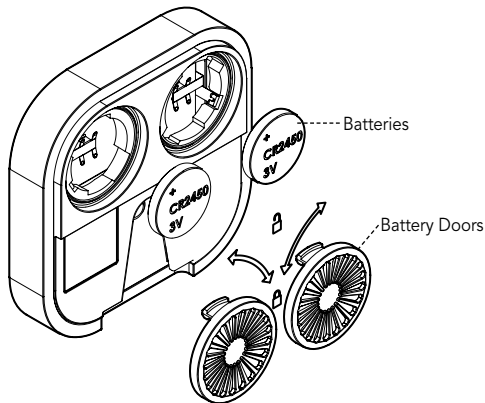

Replace the battery door and lock in place.

**⚠️ CAUTION** To prevent water from getting in the control, ensure the battery doors are in the locked position before reinstalling control.

**⚠️ CAUTION** Risk of explosion if battery is replaced by an incorrect type. Dispose of used batteries according to the instructions.

## System Status Codes

The AirTempo may display a status code if the steam system is not functioning correctly.

**CO** indicates the AirTempo control has lost communication with the steam generator. Ensure all connections are secure between the steam generator and the transceiver

**Err P** indicates an error while pairing, reset the control and redo pairing.

A complete list of steam generator status codes can be found in the MrSteam Residential Steambath Installation Operation and Maintenance Manual.

## Pairing

AirTempos are factory paired, however if more than one steam system is installed in close proximity the AirTempo controls must be paired to their transceivers to prevent interference.

To pair AirTempo use a blunt object to press the button inside the transceiver adjacent to the LED. Hold the button for 5 seconds, when the transceiver is in pairing mode the LED will turn blink blue for 2 minutes.

While the transceiver LED is blinking, press and hold the  button on AirTempo for 5 seconds until the display reads PAIR.

## Care Tips for AirTempo Controls and Steamheads

1. Use only mild soap and water on a soft cloth to clean the control and steamhead.
2. Do not use abrasive cleansers
3. If the decorative cover is damaged call MrSteam technical service for replacement parts.

## Warranty

To register your steam generator unit online and to review the MrSteam Limited Lifetime Warranty please go to:

**[blog.mrsteam.com/wr](http://blog.mrsteam.com/wr)**



(For European Version)

**DECLARATION OF CONFORMITY**

Product: MrSteam AirTempo Control  
 Item Number: AirTempo  
 Equipment Class: III



**AirTempo Control and Wireless Receiver**

The objects of the declaration described here are in conformity with the relevant requirements contained in the European 2014/53/EU Directive.

- EN 60950-1:2006 + A11:2009 + A1:2010 + A12:2011 + A2:2013.
- ETSI EN 300 220-2 V2.4.1 (2012-05)
- EN 301 489-3 V1.6.1 (2013-08)
- EN 55032: 2012
- EN 55024: 2010

Product name: AirTempo  
 Product Type: AirTempo  
 Brand: MrSteam

Mr.Steam  
 43-20 34th Street  
 Long Island City, NY 11101

**CE COMPLIANCE INFORMATION FOR THE EUROPEAN UNION**

**INSTRUCTIONS FOR DISPOSAL OF WASTE EQUIPMENT  
 BY PRIVATE USERS IN THE EUROPEAN UNION:**



This symbol on the product or its packaging indicates this product must not be disposed of with other household waste. Instead, it is the user's responsibility to dispose of their waste equipment by handing it over to a designated collection point for the recycling of waste electrical and electronic equipment. The separate collection and recycling of your waste equipment at the time of disposal will help to conserve natural resources and ensure that it is recycled in a manner that protects human health and the environment. For more information about where you can drop off your waste equipment for recycling, please contact your local city office, your household waste disposal service or location where you purchased the product.

*(For North American Version)*

**FCC/Industry Canada Two Part Statement:**

This device complies with FCC Part 15 and Industry Canada license exempt RSS standard(s). Operation is subject to the following two conditions: (1) this device may not cause interference, and (2) this device must accept any interference, including interference that may cause undesired operation of the device.

Le présent appareil est conforme aux CNR d'Industrie Canada applicables aux appareils radio exempts de licence. L'exploitation est autorisée aux deux conditions suivantes: (1) l'appareil ne doit pas produire de brouillage, et (2) l'utilisateur de l'appareil doit accepter tout brouillage radioélectrique subi, même si le brouillage est susceptible d'en compromettre le fonctionnement.

**Per Industry Canada RSS rules:**

This device complies with Health Canada's Safety Code. The installer of this device should ensure that RF radiation is not emitted in excess of the Health Canada's requirement.

Cet appareil est conforme avec Santé Canada Code de sécurité 6. Le programme d'installation de cet appareil doit s'assurer que les rayonnements RF n'est pas émis au-delà de l'exigence de Santé Canada.

Changes or modifications not expressly approved by the party responsible for compliance could void the user's authority to operate the equipment.

Les changements ou modifications non expressément approuvés par la partie responsable de la conformité pourraient annuler l'autorité de l'utilisateur à utiliser cet équipement.

**NOTE:** This equipment has been tested and found to comply with the limits for a Class B digital device, pursuant to part 15 of the FCC Rules. These limits are designed to provide reasonable protection against harmful interference in a residential installation. This equipment generates, uses and can radiate radio frequency energy and, if not installed and used in accordance with the instructions, may cause harmful interference to radio communications. However, there is no guarantee that interference will not occur in a particular installation. If this equipment does cause harmful interference to radio or television reception, which can be determined by turning the equipment off and on, the user is encouraged to try to correct the interference by one or more of the following measures:

- Reorient or relocate the receiving antenna.
- Increase the separation between the equipment and receiver.
- Connect the equipment into an outlet on a circuit different from that to which the receiver is connected.
- Consult the dealer or an experienced radio/TV technician for help.

This Class B digital apparatus complies with Canadian ICES-003.

Cet appareil numérique de la classe B est conforme à la norme NMB-003 du Canada.

**Parts List:**

Item #	Description	Used on
104208BK	Electronic Assembly Black	All
104208WH	Electronic Assembly White	All
104209	Retention Ring (AirTempo Flush)	Flush Mount
104210	Flush Mount Box (AirTempo Flush)	Flush Mount
104211	Surface Mount Holder (AirTempo Surface)	Surface Mount
104212	Wireless Receiver	All
104213XX	Round Bezel (AirTempo Flush)	Flush mount <i>(specify finish)</i>
104214XX	Square Bezel	Flush mount <i>(specify finish)</i>
104215XX	Surface Bezel (AirTempo Surface)	Surface mount <i>(specify finish)</i>
104220	AirTempo Cable	All
104117-30	30 Foot Cable	Optional
103990-60	60 Foot Cable	Optional

**Technical Specifications:**

**Wireless Receiver Unit**

Temperature operating	-20 C ~ +50 C
Temperature storage	-40 C ~ +85 C
Humidity	90%RH non-condensing
Usage type	Indoor
Dimensions	41.5 x 117.5 x 22.5 mm (1.625 x 4.875 x 0.875 in.)
Operating frequencies	865 ~ 868 MHz (European Version) 910 ~ 920 MHz (North American Version)
Operating voltage	5.0 V <i>(provided by Steam Generator Unit)</i>

**AirTempo Control Unit**

Temperature operating	-20 C ~ +60 C
Temperature storage	-30 C ~ +60 C <i>(limited by battery &amp; LCD)</i>
Humidity	100%RH condensing <i>(external surface only)</i>
IP Rating	IPX5
Usage type	Indoor
Dimensions	90.0 x 90.0 x 19.0 mm <i>(without decorative bezel)</i> (3.625 x 3.625 x 0.75 in. )
Operating frequencies	865 ~ 868 MHz (European Version) 910 ~ 920 MHz (North American Version)
Operating voltage	3.0 V
Battery Type	CR2450 Primary Manganese Dioxide Lithium Batteries <i>(replace only with battery UL1642 approved)</i>

## **Glass Mount Mask**

## **Glass Mount Mask**

## Flush Mount AirTempo

**IMPORTANT NOTE:** Flush mount components are sold separately (104232RD & 104232SQ). Contact a MrSteam representative if a flush mount kit is needed.

- Remove the surface mount bayonet from the back of the AirTempo control. The surface mount bayonet is not used when flush mounting. The surface mount decorative bezel is not used when flush mounting.
- Using the template provided on page 23, cut the hole in the desired location. Do not oversize or undersize the cutout. Ensure the template is level before cutting the hole.
- Test fit the flush mount box to ensure the hole is the correct size.
- Ensure the mounting surface is clean and dry
- Apply a thin bead of silicone in the location shown as required to create a moisture seal. Remove and discard the release paper to expose the adhesive liner.

**NOTE:** The silicone supplied by MrSteam can be used for sealing and gasketing. It cures to silicone rubber and adheres to glass, wood, metal, porcelain, ceramic tile, painted surfaces, many plastics and rubber. Surfaces must be clean and dry. Apply thin layer of product. Fit together and support if necessary. Allow excess material to cure, then trim with a sharp blade. Sealant "skins" in 5 minutes, dries to touch in 1 hour. Fully cures and bonds in 24 hrs.

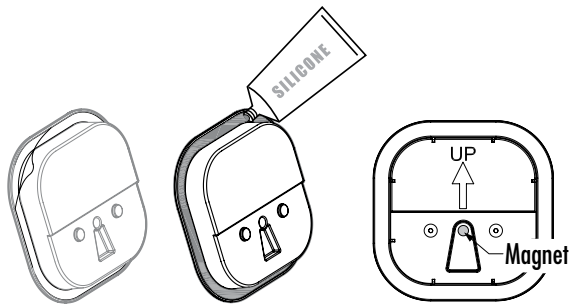

**IMPORTANT NOTE:** Do not apply excessive amounts of silicone. Do not apply silicone to any other parts of the control including the adhesive gasket. Place the flush mount box into the hole.

**IMPORTANT NOTE:** The magnet in the flush mount box should be orientated at the bottom of the box when installed.

mr.steam®

---

Place the electronic assembly into the decorative bezel as shown. The retention ring snaps onto the assembly from behind. The 3 piece assembly can then be placed into the flush mount box. There is a magnet in the box that will hold the control in place.

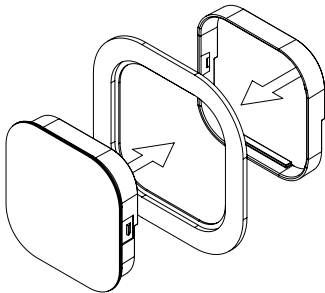

### **Template**

For Flush Mount Kit Installation

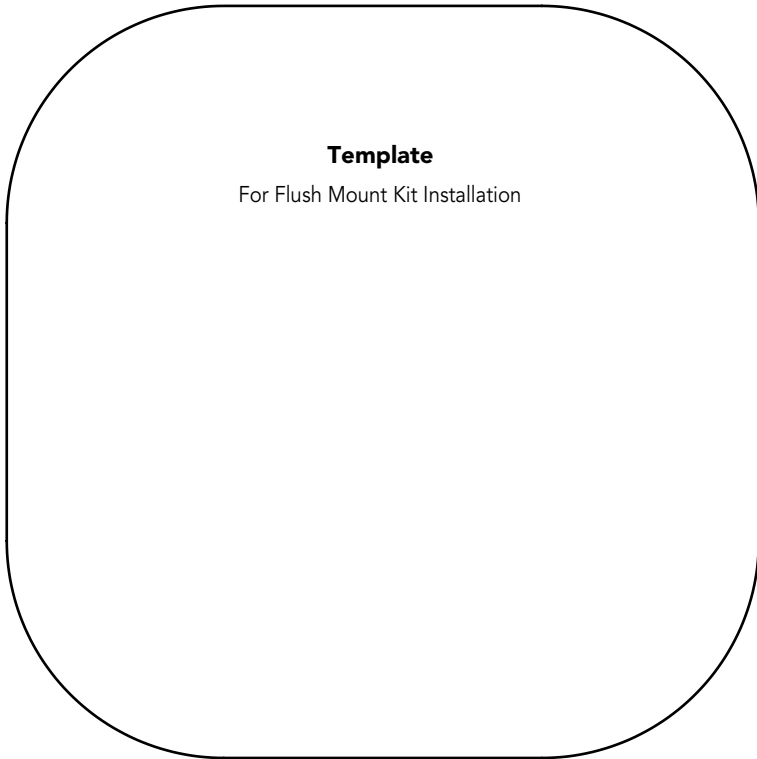

[www.mrsteam.com](http://www.mrsteam.com)

---

Products, information and specifications are subject to change without notice.  
For more information call Sales & Support at: 1.800.76.STEAM (East Coast) 1.800.72.STEAM (West Coast)

**mr.steam** Sussman-Automatic Corporation® [hello@mrsteam.com](mailto:hello@mrsteam.com) [www.mrsteam.com](http://www.mrsteam.com)  
43-20 34th Street, Long island City NY 11101 800 767 8326 | 9410 S. La Cienega Blvd., Inglewood CA 90301 800 727 8326

**mr.steam**

PN 100503 REV 3.19